

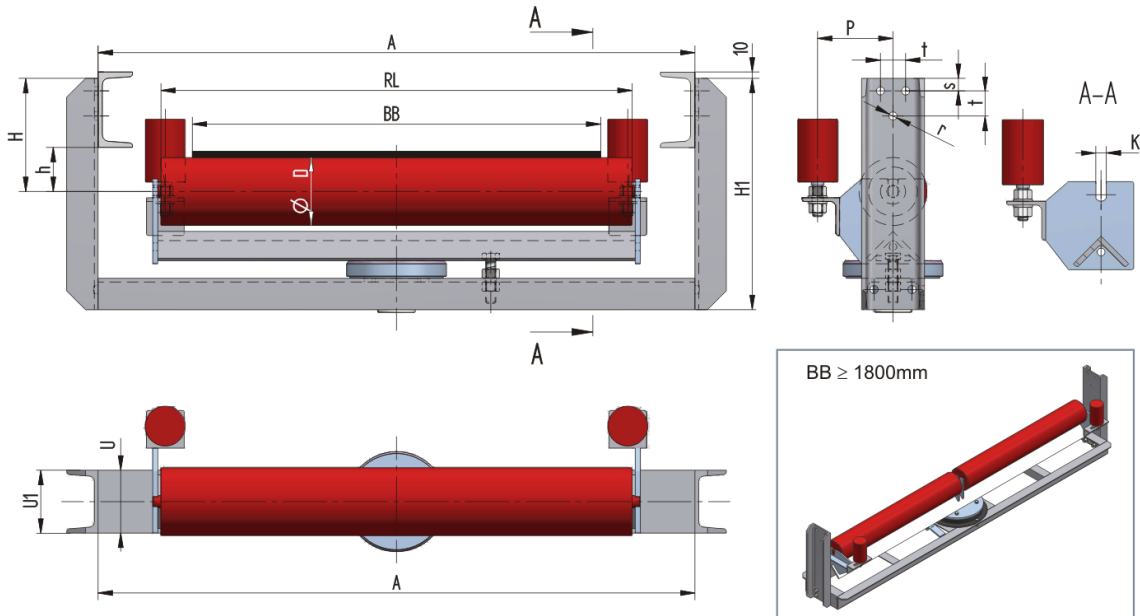

# FÖRDERANLAGEN - BELT CONVEYORS GTK PÁSOVÉ DOPRAVNÍKY

GTK, spol s r.o., CZ-687 07 TUPESY 116, okres Uherské Hradiště, Česká republika

Tel.: +420 572 520 880-9, Fax: +420 572 520 899



The weight **m** is given without rollers!

## LESU04000070-063

Weight (kg)	0
Belt width <b>BB</b> (mm)	400
Inclination °	0
Roller length <b>RL</b> (mm)	500
Hight of roller shaft above the infrastructure <b>h</b> (mm)	70
Bottom base ( <b>U</b> )	U100
Dimensions <b>H</b> (mm)	160
Dimensions <b>H1</b> (mm)	333
Base length <b>A</b> (mm)	700
Dimension <b>P</b> (mm)	115
Pricipal dimensions <b>s</b> (mm)	20
Pricipal dimensions <b>t</b> (mm)	40
Pricipal dimensions <b>r</b> (mm)	13
Pivot	OTV-30
Guard roller	63,5x100/M16



GTK spol. s r.o., CZ-68707 Tupesy 116, Czech Republik, Tel.: +420 572 520 880-9, Fax: +420 520 899  
e-mail: gtk@gktupesy.cz, www.gktupesy.cz

