

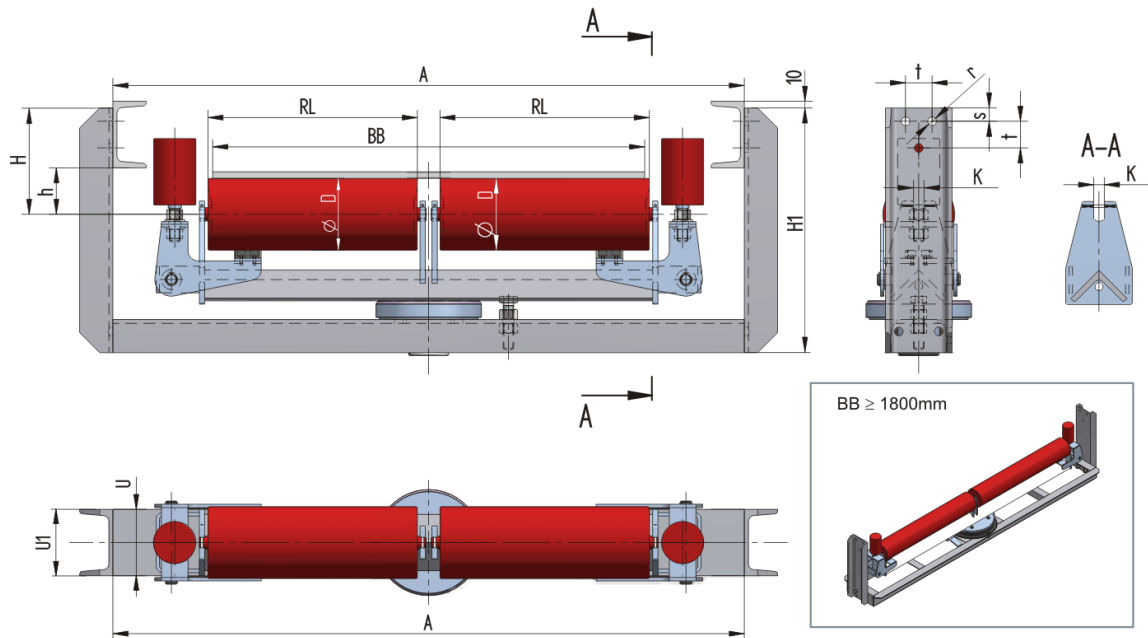

FÖRDERANLAGEN - BELT CONVEYORS GTK PÁSOVÉ DOPRAVNÍKY

GTK, spol s r.o., CZ-687 07 TUPESY 116, okres Uherské Hradiště, Česká republika

Tel.: +420 572 520 880-9, Fax: +420 572 520 899



The weight **m** is given without rollers!

LESUR04000070-063

Weight (kg)	0
Belt width BB (mm)	400
Inclination °	0
Roller length RL (mm)	2x190
Hight of roller shaft above the infrastructure h (mm)	70
Dimensions H (mm)	160
Dimensions H1 (mm)	348
Base length A (mm)	700
Pricipal dimensions s (mm)	20
Pricipal dimensions t (mm)	40
Pricipal dimensions r (mm)	13
Pivot	OTV-30
Guard roller	63,5x100/M16



GTK spol. s r.o., CZ-68707 Tupesy 116, Czech Republik, Tel.: +420 572 520 880-9, Fax: +420 520 899
e-mail: gtk@gktupesy.cz, www.gktupesy.cz

