

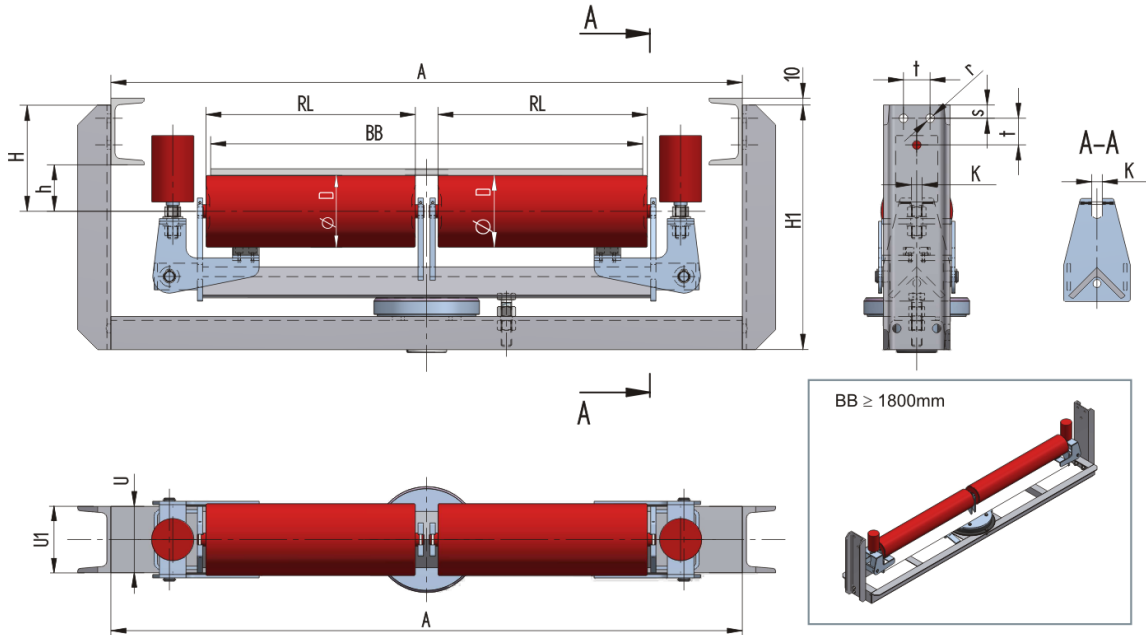

# FÖRDERANLAGEN - BELT CONVEYORS GTK PÁSOVÉ DOPRAVNÍKY

GTK, spol s r.o., CZ-687 07 TUPESY 116, okres Uherské Hradiště, Česká republika

Tel.: +420 572 520 880-9, Fax: +420 572 520 899



The weight **m** is given without rollers!

## LESUR14000070-108

Weight (kg)	0
Belt width <b>BB</b> (mm)	1400
Inclination °	0
Roller length <b>RL</b> (mm)	2x700
Hight of roller shaft above the infrastructure <b>h</b> (mm)	70
Dimensions <b>H</b> (mm)	180
Dimensions <b>H1</b> (mm)	440
Base length <b>A</b> (mm)	1800
Pricipal dimensions <b>s</b> (mm)	25
Pricipal dimensions <b>t</b> (mm)	50
Pricipal dimensions <b>r</b> (mm)	17
Pivot	OTV-40
Guard roller	63,5x100/M16



GTK spol. s r.o., CZ-68707 Tupesy 116, Czech Republik, Tel.: +420 572 520 880-9, Fax: +420 520 899  
e-mail: [gtk@gktupesy.cz](mailto:gtk@gktupesy.cz), [www.gktupesy.cz](http://www.gktupesy.cz)

